

Synergy™

A Good Fit

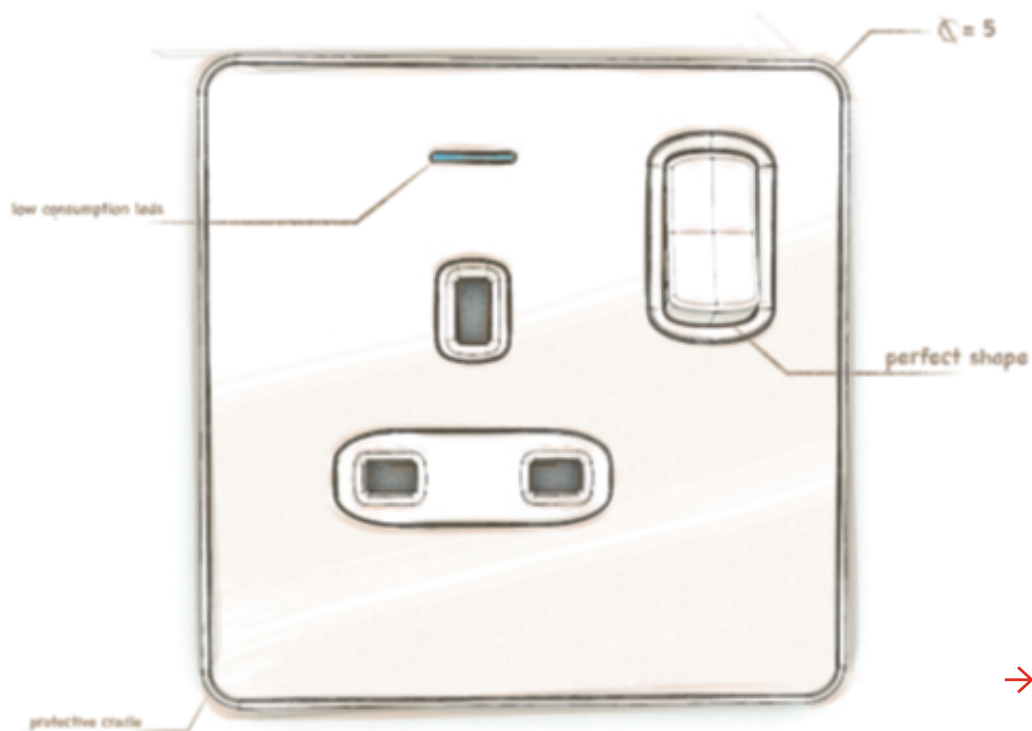

CATALOGUE
PAGES
→ INSIDE

From designing the functions...

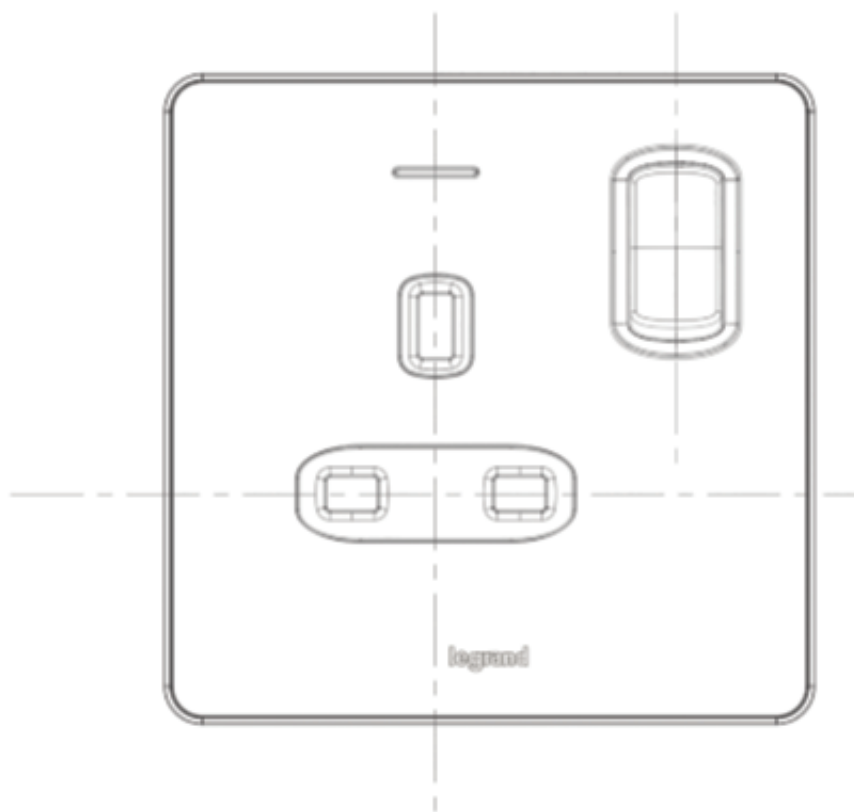

to specifying the
finishes...



SynergyTM
is a good fit – for you.



Synergy™ Authentic



Authentic full metal appeal with proven technical quality places Synergy™ Authentic in a class of its own. Its full features and superior quality are truly authentic.

Synergy™ Sleek Design



Complementary slim profile and clean outline with no visible screws characterise Synergy™ Sleek Design. Cold and warm tones, glossy and brushed surfaces – three timeless metal finishes.

Synergy™ Metalclad



Known for its durability and reliability, Synergy™ Metalclad is an all-weather series.

Synergy™ White



Perfect harmony of form and function defines Synergy™ White. An all-purpose, all-time classic.

Boasting a **Complete Range**

White. Authentic. Sleek Design. Metalclad.



Synergy™ is designed to fit your preferences right from its inception a decade ago. Today, Synergy™ renews its quality promise, enhances its features and elevates its functions to present you with four series that are carefully crafted and intricately modelled to suit any space, application and budget.

Synergy™ Authentic

Featuring Grade 430 stainless steel for polished finishes and non magnetic Grade 304L stainless steel for the brushed finish, the Synergy™ Authentic range comes with additional surface treatment for rust resistance.



Quality you can rely on - Made in UK

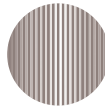

Brushed Stainless Steel

This series exudes understated elegance, adding personality to your installation.



Glossy Gold Finishing

The shiny surface of the series makes it a looker. It brings cheer to any space.



Polished Stainless Steel

This series enhances your project's character, without being over the top.

Certified quality and safety

Synergy™ Authentic comprises a complete range, providing a solution for every important function you'll need.

The British standard sockets come with ASTA certification.



Embodying Timeless Styles

Full Metal. Sturdy. Reliable.



Synergy™ Authentic embodies the familiar quality and stylish authenticity that everyone loves. Its full metal exteriors come complete with three distinctively different finishes – you are sure to find one that fits your style and demand for quality.

Synergy™ Sleek Design

Inspired by modern electronic consumer devices, Synergy™ Sleek Design embodies a slim, compact form, a surface with smooth edges and no visible screws. And its specially designed cradle sits the product perfectly flat on the wall.



Brushed Stainless Steel
The warm metal tone of this series accentuates the sleekness of this range.

Quality you can rely on - Made in UK



Glossy Gold Finishing
This finish provides an opulent impression without compromising on functionality.

Special cradle for a flat fit on the wall



Polished Stainless Steel
The smooth surface enhances the uniqueness of the series.



Synergy™ Sleek Design presents a full series of functions that complement your every installation requirement.
The British standard sockets come with ASTA certification.



And Exclusive Profiles

Flat. Screwless. Sleek.



Synergy™ Sleek Design comes in the same three beautiful finishes and is of the same high quality as Synergy™ Authentic. But Synergy™ Sleek Design has an exclusive profile and a stylised appearance emphasised by the absence of visible screws on the plate. Synergy™ Sleek Design is flat - and fit.



USB Charger

The Synergy™ USB charger ensures that you can now conveniently charge your digital gadgets whenever you want. And it makes the need for an adaptor a thing of the past. Better still, it is low in energy consumption.



CFL



LED



Halogen



Incandescent

Universal Dimmer

With the Universal Dimmer you always have the right choice: whether you need to dim incandescent or halogen lamps or to control dimmable CFLs and LEDs. This is one device that does it all - helping you to harness the full energy efficiency potential of modern loads.

Like all electronic functions of the Synergy range, the Universal Dimmers comply with EMC requirements.



RCD Sockets

Our RCD sockets provide you with enhanced safety. Available in both ELO and ELR modes, the RCD sockets protect you against hazardous situations while keeping your important equipment running.

Coupled with **Enduring Functions**

USB Chargers. Universal Dimmers. RCD Sockets.



Synergy™ is a thoughtful range that goes beyond attending to your basic needs. Keeping in pace with your modern lifestyles, Synergy™ offers new functions so that your safety and energy efficiency goals are met. Synergy™ is a range you can count on to fit...you.

Grid Plates - a perfect blend of style and versatility

Packing in up to 24 modules, Synergy™ Grid Plates satisfy your need for multiple functions. For seamless integration with Synergy™ Authentic and Sleek Design, switch modules are available in Brushed and Polished Stainless Steel, Glossy Gold, White and Anthracite. Grid plates come in all sizes from one to 24 gang.



Front plates for Arteor mechanisms

Extending the spectrum of Synergy™ functions is now possible with these carrier plates. Simply match the plates with functions from the Arteor™ range.



Suited for Every Purpose

Multiple functions. Single control point.



Synergy™ goes the distance with its complete range of Grid Plates. As a result, you can enjoy unrivalled versatility with no compromise on style. Whether it is to integrate switches with dimmers, TV or data sockets, Synergy™ responds to the challenge with fitting answers.



Red/Green LED

The illuminated switches of Synergy™ White are a demonstration of perfect lithophane technique. LEDs are invisible unless activated, combining a low power consumption with sufficient brightness - all at once.



Blue LED

The LED in the Synergy™ Authentic and Sleek Design collections enhances their technological appeal. Its low power consumption and long life make it particularly energy efficient.

Unique LED kits for location or power indication. Invisible until activated.

The blue LED is integrated into the surface, showcasing depth contrast.

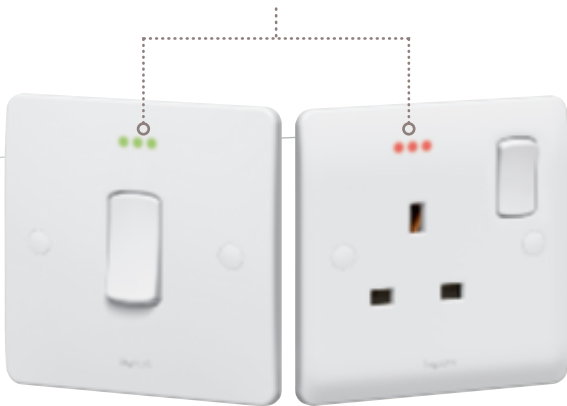

Optimised Wiring Space

Compact mechanism for maximum wiring space.

Ease of Installation

Large angled easy-to-access cable entries and captive screws.

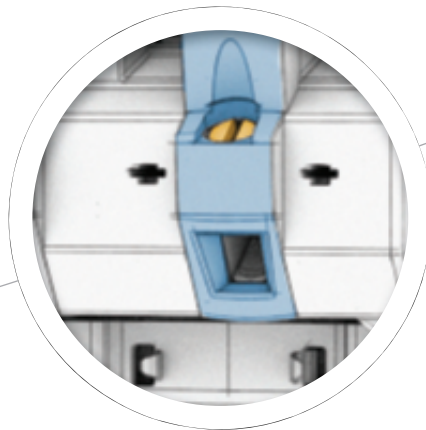
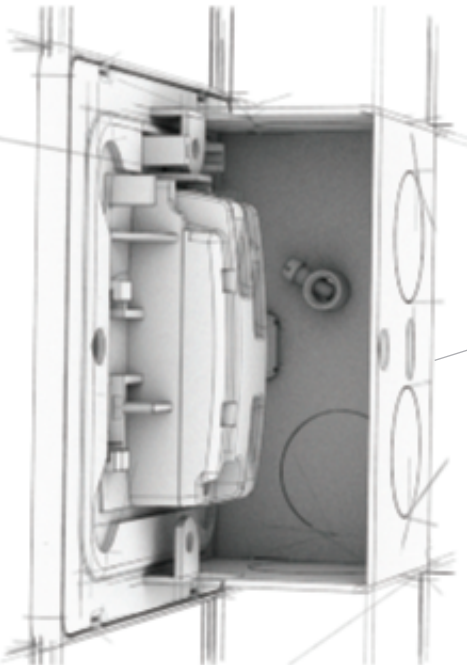

Strip length indicator - avoids waste of wires

Complete with **Easy and Safe Handling**

Compact. Simple. Safe.

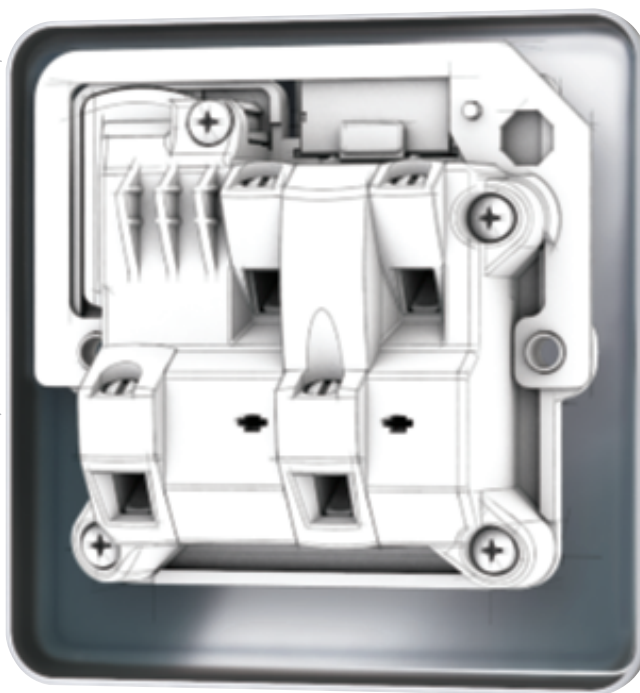

Synergy™ is more than just an aesthetically pleasing and functionally convenient range. The carefully engineered mechanism also makes this British standard monobloc range a breeze to install and handle. What's more? And the quality that is uniquely Synergy™ means installers can simply fit and forget.



Hotels

Offices



Homes

Institutions



And Versatile Spatial Fit

Homes. Offices. Hotels. Institutions.

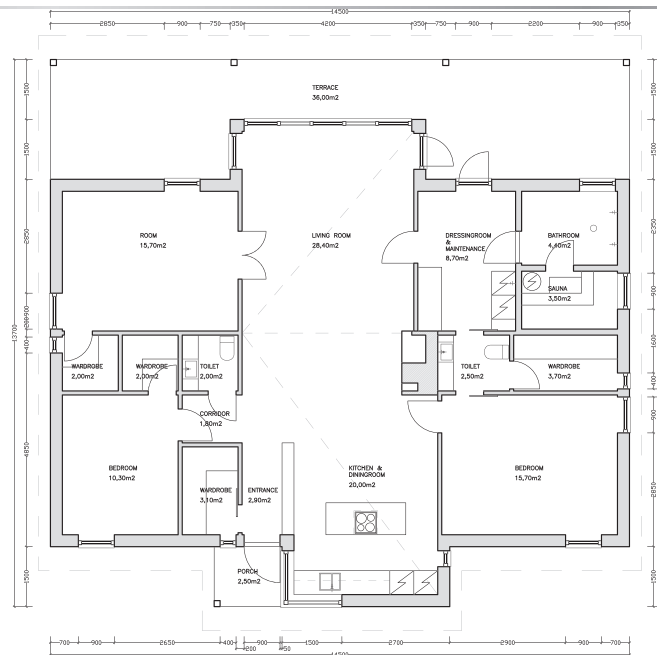

Synergy™ provides a comprehensive range that can complement any interior space and design. No matter whether your purpose is business, leisure or a combination of both, Synergy™ is your right fit – in every sense.

Homes

Your home is your personal haven. That is why besides giving you visually pleasing switches, the Synergy™ range also heightens your comfort and safety with its full feature functions.



2 Gang Switched Socket with Indicator



Double Pole Switch



Universal Dimmer



1 Gang Switched Socket



Double USB Socket



Offices

Your office is where you want to get things done. The clean, strong lines that personify the Synergy™ range make for less distraction so that you can focus on being productive.



2 Gang Switched Socket with Indicator



1 Gang Switch



1 Gang Switched Socket



RJ 45 Twin Socket



3 Gang - 2 Way Switch



Hotels

Hotels are where you want to feel welcomed and pampered. With dedicated hotel-specific functions, the Synergy™ range promises a harmonious, complete experience. For installers this means – one range fits all.



Shaver Socket



Key Card Switch



3 Gang - 2 Way Switch



Hotel Call Indicator



2 Gang Switch



RJ 45 Twin Socket



Institutions

Institutions appreciate practicality, robustness and effortless elegance. The Synergy™ collections stand for perfect synergy between proven quality and design excellence. Particularly, the Metalclad range provides for that much needed durability.



2 Gang Switched Socket with Indicator



1 Gang Switched Socket



RJ 45 Twin Socket



1 Gang - 1 Way Switch



3 Gang - 2 Way Switch





**Synergy™
White**

**Synergy™
Authentic**

**Synergy™
Sleek Design**

**Synergy™
Metalclad**



1 Gang Switch



1 Gang Switch



1 Gang Switch



1 Gang Switch



1 Gang Switched Socket



1 Gang Switched Socket



1 Gang Switched Socket



1 Gang Switched Socket



1 Gang 1000 W Dimmer



2 Gang Dimmer



Universal Dimmer



Fused Connection Unit



Data Socket



Data Socket



Data Socket



Data Socket



TV Antenna Socket



TV-R-SAT Socket



USB Charger



TV Antenna Socket



It's Definitely An All-time Favourite

Installers. Designers. Users.



Synergy™ is well liked for its quality, its features and its functions. Today, a decade on, we renew our quality promise and present Synergy™ with enhanced features and elevated functions. Although times may have changed and needs may have become more complex, there is no doubt that Synergy™ continues to be a good fit.



CATALOGUE Contents

23-27	Synergy™ White
28-33	Synergy™ Authentic
34-39	Synergy™ Sleek Design
40-41	Synergy™ Metalclad
42-43	Synergy™ Grid Modules
44-45	Selection Chart Grid Modules
46	Selection Chart Front Plates for Arteor mechanisms
47-48	Catalogue Number Index

Synergy™

single pole switches, single pole push and key switches, rotary dimmers - white



7 300 00



7 300 06



7 311 51



7 301 56

Front plates: white thermoset. Terminal screws captive and backed off ready for cabling - large angled terminal entries
Compact mechanism for maximised wiring space. Supplied with faceplate screw caps

Pack	Cat.Nos	Single pole plate switches 10 AX - 250 V~	Pack	Cat.Nos	3 pole fan switch 10 A - 250 V~	
10	7 300 00	<p>Conform to BS EN 60669-1 For flush-mounting, back box to be min. 16 mm deep ASTA licence </p> <p>Nominal plate dimensions: 86 x 86 mm</p> <p>1 gang - 1 way 1 gang - 2 way 1 gang - intermediate</p> <p>2 gang - 1 way 2 gang - 2 way</p> <p>3 gang - 1 way 3 gang - 2 way</p> <p>Nominal plate dimensions: 86 x 146 mm</p> <p>4 gang - 2 way</p> <p>6 gang - 2 way</p>	10	7 300 09	<p>Conform to BS EN 60669-1: 2000 With integrated padlockable safety block in OFF position. Flush-mounting back box: min 25 mm deep Nominal plate dimensions: 86 x 86 mm</p> <p>3 pole fan switch</p>	
10	7 300 01		1 gang - 2 way			
10	7 300 05		1 gang - intermediate			
10	7 300 24		2 gang - 1 way			
10	7 300 02		2 gang - 2 way			
10	7 301 24		3 gang - 1 way			
10	7 300 03		3 gang - 2 way			
5	7 300 04		4 gang - 2 way			
5	7 300 06		6 gang - 2 way			
10	7 301 30		<p>Conform to BS EN 60669-1 For flush-mounting, back box to be min. 16 mm deep Nominal plate dimensions: 86 x 86 mm</p> <p>1 gang - 1 way 1 gang - 2 way</p> <p>2 gang - 1 way 2 gang - 2 way</p> <p>3 gang - 1 way 3 gang - 2 way</p>	1	7 311 51	<p>Push on/off rotary universal dimmer 5 W/300 W 100 - 240 V~ - 50/60 Hz</p> <p>Conform to IEC 60669-2-1 For flush-mounting back box to be min. 40 mm deep Equipped with overvoltage and short-circuit protection Screw terminals. For all types of lamps: - dimmable LEDs: 5 W to 75 W - dimmable compact fluorescent lamps: 5 W to 75 W - halogen with ferromagnetic or electronic transformer: 5 VA to 300 VA - fluorescent tube - ballast: 5 VA to 300 VA - halogen and incandescent 230 V: 5 W to 300 W When switched on, gradually (2 seconds) lights up at the level set before last switch-off Nominal plate dimensions: 86 x 86 mm</p> <p>1 gang</p>
10	7 301 31	1 gang - 2 way				
10	7 301 34	2 gang - 1 way				
10	7 301 32	2 gang - 2 way				
10	7 301 35	3 gang - 1 way				
10	7 301 33	3 gang - 2 way				
5	7 300 07	<p>Single pole push switches 10 A - 250 V~</p> <p>Conform to BS EN 60669-1 For flush-mounting, back box to be min. 16 mm deep ASTA licence </p> <p>Nominal plate dimensions: 86 x 86 mm</p> <p>1 gang - 2 way push switch</p>		1	7 301 56	<p>Push on/off rotary dimmers 400 W 100 - 240 V~ - 50/60 Hz</p> <p>Conform to BS EN 60669-1 For flush-mounting, back box to be min. 25 mm deep</p> <p>Nominal plate dimensions: 86 x 86 mm</p> <p>1 gang - 2 way</p>
5	7 300 11	1 gang - 2 way push switch marked "PRESS"		1	7 301 57	2 gang - 2 way
5	7 301 07	1 gang - 2 way push switch with bell symbol		1	7 300 49	<p>Nominal plate dimensions: 86 x 146 mm</p> <p>4 gang - 2 way</p>
10	7 300 08	<p>Single pole key switch 10 AX - 250 V~</p> <p>Conform to BS EN 60669-1: 2000 Key supplied. For flush-mounting, back box to be min. 16 mm deep. Nominal plate dimensions: 86 x 86 mm</p> <p>1 gang - 2 way</p>		1	7 301 50	<p>Push on/off rotary dimmer 1000 W 100-240 V/50-60 Hz</p> <p>Conform to BS EN 60669-1 - For flush-mounting back box to be min. 40 mm deep - 60-1000 W (230 V) - 60-500 W (127 V) for incandescent and halogen lamps 60-600 VA (230 V) - 60-300 VA (127 V) for halogen lamps with electronic transformers 60-100 VA (230 V) - 60-500 VA (127 V) for halogen lamps with ferromagnetic transformers Nominal plate dimensions: 86 x 86 mm</p> <p>1 gang</p>

Surface mounting boxes, p. 27



Synergy™

double pole switches - white



7 301 10

7 300 22

Front plates: white thermoset
Terminal screws captive and backed off ready for cabling - large angled terminal entries
Compact mechanism for maximised wiring space
Supplied with faceplate screw caps

Pack	Cat.Nos	Double pole switches 20 A - 250 V~
10	7 300 10	Conform to BS EN 60669-1 For flush-mounting, back box to be min. 25 mm deep Use cord outlet accessory box Cat.No 7 300 53 for external cord outlet ASTA licence Nominal plate dimensions: 86 x 86 mm DP switch
10	7 300 12	DP switch + red LED power indicator LED invisible until activated
10	7 301 10	DP switch marked "WATER HEATER"
10	7 301 12	DP switch marked "WATER HEATER" + red LED power indicator LED invisible until activated

Pack	Cat.Nos	Double pole switches 45 A - 250 V~
10	7 300 22	Conform to BS EN 60669-1 ASTA licence For flush-mounting, back box to be min. 45 mm deep Nominal plate dimensions: 86 x 86 mm DP switch
10	7 300 23	DP switch + red LED power indicator LED invisible until activated
10	7 301 22	DP switch red rocker marked "COOKER"
5	7 300 20	Nominal plate dimensions: 146 x 86 mm DP switch
5	7 300 21	DP switch + red LED power indicator LED invisible until activated
5	7 301 20	DP switch red rocker marked "COOKER"

Synergy™

telephone, data and TV sockets - white



7 300 50

7 300 57

7 300 43

Front plates: white thermoset
Terminal screws captive and backed off ready for cabling - large angled terminal entries
Compact mechanism for maximised wiring space
Supplied with faceplate screw caps

Pack	Cat.Nos	Euro module front plates
10	7 300 99	Suitable for use with standard 25 x 50 mm Euro data module inserts 1 gang - 86 x 86 mm 2 modules - aperture size 50 x 50 mm
10	7 301 00	2 gang - 86 x 146 mm 4 modules - aperture size 50 x 100 mm

Pack	Cat.Nos	Telephone sockets
10	7 300 50	For flush-mounting, back box to be min. 35 mm deep Nominal plate dimensions: 86 x 86 mm UK master
10	7 300 51	UK secondary
10	7 300 54	RJ 11/RJ 12 - single

Pack	Cat.Nos	Data sockets - Cat. 6
1	7 300 56	Rapid cable connection For flush-mounting, back box to be min. 35 mm deep Nominal plate dimensions: 86 x 86 mm RJ 45 - single
1	7 300 57	RJ 45 - twin

Pack	Cat.Nos	Television sockets
10	7 300 40	For flush-mounting, back box to be min. 35 mm deep Nominal plate dimensions: 86 x 86 mm Screened TV socket single - male
10	7 301 40	Screened TV socket single - female
10	7 301 44	Screened TV socket single pass through - female
10	7 301 45	Screened TV socket single terminal - female
1	7 300 41	SAT socket single - "F" type
1	AVAILABLE SEPT 2016 7 301 41	TV-SAT socket
1	7 300 43	TV-R-SAT socket "F" type

Synergy™

British standard socket outlets and RCD sockets - white



7 300 65



7 300 60



7 300 70



6 781 33



6 781 38

Front plates: white thermoset
Terminal screws captive and backed off ready for cabling - large angled terminal entries
Compact mechanism for maximised wiring space
Supplied with faceplate screw caps

Pack	Cat.Nos	Socket outlets 13 A - 250 V~
10	7 300 65	Conform to BS 1363: Part. 2 With safety shutter mechanism For flush-mounting, back box to be min. 25 mm deep ASTA licence Unswitched 1 gang Nominal plate dimensions: 86 x 86 mm
5	7 300 75	2 gang Nominal plate dimensions: 86 x 146 mm
10	7 300 66	Single pole - switched 1 gang Nominal plate dimensions: 86 x 86 mm
5	7 300 76	2 gang Nominal plate dimensions: 86 x 146 mm
10	7 300 67	Socket outlets 13 A - 250 V~ Special earth pin With safety shutter mechanism For flush-mounting, back box to be min. 25 mm deep Double pole - switched 1 gang Nominal plate dimensions: 86 x 86 mm
5	7 300 77	2 gang Nominal plate dimensions: 86 x 146 mm
10	7 300 60	Double pole socket outlets 13 A - 250 V~ Conform to BS 1363: Part. 2 With safety shutter mechanism For flush-mounting, back box to be min. 25 mm deep ASTA licence Switched 1 gang Nominal plate dimensions: 86 x 86 mm
5	7 300 70	2 gang Nominal plate dimensions: 86 x 146 mm
10	7 300 61	Switched with red LED power indicator LED invisible until activated 1 gang Nominal plate dimensions: 86 x 86 mm
5	7 300 71	2 gang Nominal plate dimensions: 86 x 146 mm

Pack	Cat.Nos	Double pole socket outlets 13 A - 250 V~ (continued)
10	7 300 64	Conform to BS 1363: Part. 2 With safety shutter mechanism For flush-mounting, back box to be min. 25 mm deep ASTA licence Switched for standard and clean earth applications 1 gang Nominal plate dimensions: 86 x 86 mm
5	7 300 74	2 gang Nominal plate dimensions: 86 x 146 mm
10	7 301 62	Switched with red rocker 1 gang Nominal plate dimensions: 86 x 86 mm
5	7 301 61	2 gang Nominal plate dimensions: 86 x 146 mm
1	6 781 33	RCD sockets 13 A - 250 V~ Conform to BS 7288: 1990 and BS 1363 - Part 2: 1995 Conventional earth pin release shutter Maximum operating current 16 A Electronic RCD module with a membrane switch for "test and reset" Flush mounting back box : min. 25 mm deep ELO - DP 30 mA Trips in the event of a power failure Ideal for applications where it is desirable to prevent automatic reactivation of equipment after a power failure For hazardous, e.g. machinery, power tools
1	6 781 37	1 gang Nominal plate dimensions: 86 x 86 mm
1	6 781 34	2 gang Nominal plate dimensions: 86 x 146 mm
1	6 781 38	ELR - DP 30 mA Trips in the event of a power failure Ideal for applications where it is desirable to automatically re-activate equipment after a power failure E.g. fridge, freezer, unmanned areas
1	6 781 34	1 gang Nominal plate dimensions: 86 x 86 mm
1	6 781 38	2 gang Nominal plate dimensions: 86 x 146 mm

Synergy™

British standard socket outlets - white (continued)



7 300 89



7 300 69

Front plates: white thermoset
Terminal screws captive and backed off ready for cabling - large angled terminal entries
Compact mechanism for maximised wiring space
Supplied with faceplate screw caps

Pack	Cat.Nos	Socket outlets 15 A - 250 V~
10	7 300 88	Conform to BS 546 Patented 3 pin safety shutter mechanism For flush-mounting, back box to be min. 35 mm deep Nominal plate dimensions: 86 x 86 mm 1 gang - unswitched
10	7 300 89	1 gang - switched, single pole
5	7 300 85	Socket outlets 15 A - 127 V~ Standard terminal screws For flush-mounting, back box to be min. 35 mm deep 1 gang unswitched Nominal plate dimensions: 86 x 86 mm
5	7 300 86	2 gang unswitched Nominal plate dimensions: 86 x 146 mm
10	7 300 68	Socket outlets 5 A - 250 V~ Conform to BS 546 Patented 3 pin safety shutter mechanism For flush-mounting, back box to be min. 25 mm deep Nominal plate dimensions: 86 x 86 mm 1 gang - unswitched
10	7 300 69	1 gang - switched, single pole
10	7 300 59	Socket outlet 2 A - 250 V~ Conform to BS 546 For flush-mounting, back box to be min. 25 mm deep Nominal plate dimensions: 86 x 86 mm 1 gang - unswitched

Synergy™

Euro-US socket outlets and shaver socket - white



7 300 84



7 300 83

Front plates: white thermoset
Terminal screws captive and backed off ready for cabling - large angled terminal entries
Compact mechanism for maximised wiring space
Supplied with faceplate screw caps

Pack	Cat.Nos	Socket outlet combined UK / Euro - US 13 A - 10/16 A
10	7 300 84	For flush-mounting, back box to be min. 25 mm deep Nominal plate dimensions: 86 x 86 mm 1 gang - unswitched UK - 13 A / EURO-US - 10/16 A - 250 V~
10	7 300 80	Euro - US socket outlets For flush-mounting, back box to be min. 25 mm deep Nominal plate dimensions: 86 x 86 mm 10 A - 127 V~ 16 A - 250 V~ 1 gang - unswitched
10	7 300 81	2 gang - unswitched
10	7 300 82	1 gang - switched
10	7 300 83	1 gang - unswitched + 10 AX 1 way switch
1	7 300 90	Shaver socket Conform to BS EN 61558-2-5 Suitable for use with European, British and Australian 2 pin plugs Rating: 20 VA IP 24 Screwless live and neutral terminals For flush-mounting, back box to be min. 45 mm deep Nominal plate dimensions: 146 x 86 mm 230 V - 120 V~ - 50/60 Hz

Synergy™ - cooker control units, fused connection units and cable outlets - white



7 300 29



7 300 26

Front plates: white thermoset
Terminal screws captive and backed off ready for cabling - large angled terminal entries
Compact mechanism for maximised wiring space
Supplied with faceplate screw caps

Pack	Cat.Nos	Cooker control units 250 V~
5	7 300 28	Conform to BS 4177 For flush-mounting, back box to be min. 45 mm deep Nominal plate dimensions: 86 x 146 mm 45 A DP switch + 13 A DP switched socket outlet
5	7 300 29	45 A DP switch + 13 A DP switched socket outlet + red LED power indicator LED invisible until activated
Fused connection units 13 A - 250 V~		
Conform to BS 1363: Part 4 Fused 13 A (fuse supplied) Front cable outlet with cord grip Locked captive fuse carrier (padlockable) For flush-mounting, back box to be min. 25 mm deep Nominal plate dimensions: 86 x 86 mm		
Unswitched		
10	7 300 32	With cord outlet
10	7 300 33	With red LED power indicator LED invisible until activated
Double pole switched		
10	7 300 36	With cord outlet
10	7 300 37	With red LED power indicator and cord outlet LED invisible until activated
Cable outlets		
Conform to BS 5733 Fitted with cable clamp and outlet membrane Nominal plate dimensions: 86 x 86 mm		
20 A - 250 V~		
10	7 300 19	For flush-mounting, back box to be min. 35 mm deep With terminal block
45 A - 250 V~		
5	7 300 26	For flush-mounting, back box to be min. 45 mm deep With terminal block

Synergy™ - blanking plates, accessories and surface mounting boxes - white



7 300 96



7 301 58



7 364 06



7 364 11

Pack	Cat.Nos	Blanking plates
10	7 300 95	1 gang Nominal plate dimensions: 86 x 86 mm
10	7 300 96	2 gang Nominal plate dimensions: 86 x 146 mm
Accessories		
Electronic LED		
All relevant Synergy white functions are designed to accept the LED packs for fitting at time of installation or retrospectively by a qualified person Can be used with fluorescent light		
10	7 301 58	Electronic LED locator pack green diodes: max. current 0.2 mA provides illumination for function (e.g. switch) location in low light
10	7 300 58	Electronic LED power indicator pack red diodes: nominal current 2 mA provides indication of "power on" condition in such functions as sockets and control switches
Cord outlet		
10	7 300 53	1 gang box Nominal plate dimensions: 86 x 86 mm
Surface-mounting moulded boxes		
10	7 364 06	1 gang, 35 mm deep 86 x 86 mm
10	7 364 07	1 gang, 50 mm deep and cable grip 86 x 86 mm
5	7 364 10	2 gang, 35 mm deep 86 x 146 mm
5	7 364 11	2 gang, 50 mm deep and cable grip 86 x 146 mm
5	7 364 13	2 x 1 gang, 35 mm deep 86 x 172 mm



8 330 00



8 332 02



8 334 03



8 331 51



8 333 57

Slim front plate:

BSS: Plates made of austenitic Stainless Steel - non-magnetic - grade 304 L

PSS: Plates made of Stainless Steel + rust resistance

GG: Plates made of Stainless Steel + rust resistance

Terminal screws captive and backed off ready for cabling - large angled terminal entries. Compact mechanism for maximum wiring space

Single pole plate switches 10 AX - 250 V~

Pack	Cat.Nos	
		Conform to BS EN 60669-1 For flush-mounting, back box to be min. 16 mm deep
		1 gang - 1-way switch Nominal plate dimensions: 86 x 86 mm
1	8 330 00	● Brushed stainless steel
1	8 332 00	● Polished stainless steel
1	8 334 00	● Glossy gold
		1 gang - 2-way switch Nominal plate dimensions: 86 x 86 mm
1	8 330 01	● Brushed stainless steel
1	8 332 01	● Polished stainless steel
1	8 334 01	● Glossy gold
		1 gang - intermediate switch Nominal plate dimensions: 86 x 86 mm
1	8 330 05	● Brushed stainless steel
1	8 332 05	● Polished stainless steel
1	8 334 05	● Glossy gold
		2 gang - 2-way switch Nominal plate dimensions: 86 x 86 mm
1	8 330 02	● Brushed stainless steel
1	8 332 02	● Polished stainless steel
1	8 334 02	● Glossy gold
		3 gang - 2-way switch Nominal plate dimensions: 86 x 86 mm
1	8 330 03	● Brushed stainless steel
1	8 332 03	● Polished stainless steel
1	8 334 03	● Glossy gold
		4 gang - 2-way switch Nominal plate dimensions: 86 x 146 mm
1	8 330 04	● Brushed stainless steel
1	8 332 04	● Polished stainless steel
1	8 334 04	● Glossy gold

Single pole push switches 10 A - 250 V~

		Conform to BS EN 60669-1 For flush-mounting, back box to be min. 16 mm deep Nominal plate dimensions: 86 x 86 mm
		1 gang - 2-way push switch
1	8 330 07	● Brushed stainless steel
1	8 332 07	● Polished stainless steel
1	8 334 07	● Glossy gold

Single pole plate switches 20 AX - 250 V~

		Conform to BS EN 60669-1 For flush-mounting, back box to be min. 16 mm deep Nominal plate dimensions: 86 x 86 mm
		1 gang - 2-way switch
1	8 331 31	● Brushed stainless steel
1	8 333 31	● Polished stainless steel
1	8 335 31	● Glossy gold

Single pole plate switches 20 AX - 250 V~

Pack	Cat.Nos	
		Conform to BS EN 60669-1 For flush-mounting, back box to be min. 16 mm deep Nominal plate dimensions: 86 x 86 mm
		2 gang - 2-way switch
1	8 331 32	● Brushed stainless steel
1	8 333 32	● Polished stainless steel
1	8 335 32	● Glossy gold
		3 gang - 2-way switch
1	8 331 33	● Brushed stainless steel
1	8 333 33	● Polished stainless steel
1	8 335 33	● Glossy gold

Push on/off rotary universal dimmer 5 W/300 W

		1 gang Conform to IEC 60669-2-1 For flush-mounting back box to be min. 40 mm deep Equipped with overvoltage and short-circuit protection Screw terminals. For all types of lamps: - dimmable LEDs: 5 W to 75 W - dimmable compact fluorescent lamps: 5 W to 75 W - halogen with ferromagnetic or electronic transformer: 5 VA to 300 VA - fluorescent tube - ballast: 5 VA to 300 VA - halogen and incandescent 230 V: 5 W to 300 W When switched on, gradually (2 seconds) lights up at the level set before last switch-off Nominal plate dimensions: 86 x 86 mm
1	8 331 51	● Brushed stainless steel
1	8 333 51	● Polished stainless steel
1	8 335 51	● Glossy gold

Push on/off rotary dimmer 400 W 100-240 V~ - 50/60 Hz

		Conform to BS EN 60669-1-2 For flush-mounting, back box to be min. 25 mm deep Nominal plate dimensions: 86 x 86 mm
		1 gang - 2 way
1	8 331 56	● Brushed stainless steel
1	8 333 56	● Polished stainless steel
1	8 335 56	● Glossy gold
		2 gang - 2 way
1	8 331 57	● Brushed stainless steel
1	8 333 57	● Polished stainless steel
1	8 335 57	● Glossy gold

Push on/off rotary dimmer 1000 W 100-240 V/50-60 Hz

		Conform to BS EN 60669-1 - For flush-mounting back box to be min. 40 mm deep - 60-1000 W (230 V) - 60-500 W (127 V) for incandescent and halogen lamps 60-600 VA (230 V) - 60-300 VA (127 V) for halogen lamps with electronic transformers 60-100 VA (230 V) - 60-500 VA (127 V) for halogen lamps with ferromagnetic transformers Nominal plate dimensions: 86 x 86 mm
		1 gang
1	8 331 50	● Brushed stainless steel
1	8 333 50	● Polished stainless steel
1	8 335 50	● Glossy gold



8 334 09



8 330 10



8 332 16



8 334 21



8 334 12



8 330 22



8 332 23

Slim front plate:

BSS: Plates made of austenitic Stainless Steel - non-magnetic - grade 304 L



PSS: Plates made of Stainless Steel + rust resistance



GG: Plates made of Stainless Steel + rust resistance

Terminal screws captive and backed off ready for cabling - large angled terminal entries

Compact mechanism for maximum wiring space

Pack	Cat.Nos	3 pole fan switch 10 A - 250 V~
1	8 330 09	Conform to BS EN 60669-1: 2000 With integrated padlockable safety block in OFF position. Flush mounting back box: min. 25 mm deep Nominal plate dimensions: 86 x 86 mm  <ul style="list-style-type: none"> ● Brushed stainless steel ● Polished stainless steel ● Glossy gold
1	8 332 09	
1	8 334 09	

Pack	Cat.Nos	Double pole switches 20 A - 250 V~
1	8 330 10	Conform to BS EN 60669-1 For flush-mounting, back box to be min. 25 mm deep Use cord outlet accessory Cat.No 7 300 53 for external cord outlet Nominal plate dimensions: 86 x 86 mm DP switch  <ul style="list-style-type: none"> ● Brushed stainless steel ● Polished stainless steel ● Glossy gold
1	8 332 10	
1	8 334 10	
1	8 330 16	DP switch + cord outlet + blue LED power indicator  <ul style="list-style-type: none"> ● Brushed stainless steel ● Polished stainless steel ● Glossy gold
1	8 332 16	
1	8 334 16	
1	8 330 12	DP switch + blue LED power indicator  <ul style="list-style-type: none"> ● Brushed stainless steel ● Polished stainless steel ● Glossy gold
1	8 332 12	
1	8 334 12	

Pack	Cat.Nos	Double pole switches 45 A - 250 V~
1	8 330 22	Conform to BS EN 60669-1 For flush-mounting, back box to be min. 45 mm deep 1 gang switch Nominal plate dimensions: 86 x 86 mm  <ul style="list-style-type: none"> ● Brushed stainless steel ● Polished stainless steel ● Glossy gold
1	8 332 22	
1	8 334 22	
1	8 330 23	1 gang switch + blue LED power indicator Nominal plate dimensions: 86 x 86 mm  <ul style="list-style-type: none"> ● Brushed stainless steel ● Polished stainless steel ● Glossy gold
1	8 332 23	
1	8 334 23	
1	8 330 21	1 gang switch + blue LED power indicator large plate Nominal plate dimensions: 146 x 86 mm  <ul style="list-style-type: none"> ● Brushed stainless steel ● Polished stainless steel ● Glossy gold
1	8 332 21	
1	8 334 21	



Slim front plate:

BSS: Plates made of austenitic Stainless Steel - non-magnetic - grade 304 L

PSS: Plates made of Stainless Steel + rust resistance

GG: Plates made of Stainless Steel + rust resistance

Terminal screws captive and backed off ready for cabling - large angled terminal entries

Compact mechanism for maximum wiring space

Pack	Cat.Nos	Telephone sockets
		For flush-mounting, back box to be min. 35 mm deep Nominal plate dimensions: 86 x 86 mm
1	8 330 50	 ● Brushed stainless steel ● Polished stainless steel ● Glossy gold
1	8 332 50	
1	8 334 50	
1	8 330 51	 ● Brushed stainless steel ● Polished stainless steel ● Glossy gold
1	8 332 51	
1	8 334 51	
1	8 330 54	 ● Brushed stainless steel ● Polished stainless steel ● Glossy gold
1	8 332 54	
1	8 334 54	
		Data sockets Cat. 6
		Rapid cable connection For flush-mounting, back box to be min. 35 mm deep Nominal plate dimensions: 86 x 86 mm
1	8 330 56	 ● Brushed stainless steel ● Polished stainless steel ● Glossy gold
1	8 332 56	
1	8 334 56	
1	8 330 57	 ● Brushed stainless steel ● Polished stainless steel ● Glossy gold
1	8 332 57	
1	8 334 57	

Pack	Cat.Nos	Television sockets
		For flush-mounting, back box to be min. 35 mm deep Screened Nominal plate dimensions: 86 x 86 mm
1	8 330 40	 ● Brushed stainless steel ● Polished stainless steel ● Glossy gold
1	8 332 40	
1	8 334 40	
1	8 330 41	 ● Brushed stainless steel ● Polished stainless steel ● Glossy gold
1	8 332 41	
1	8 334 41	
1	8 330 43	 ● Brushed stainless steel ● Polished stainless steel ● Glossy gold
1	8 332 43	
1	8 334 43	



8 330 65



8 332 75



8 334 67



8 330 60



8 332 71

Slim front plate:

BSS: Plates made of austenitic Stainless Steel - non-magnetic - grade 304 L

PSS: Plates made of Stainless Steel + rust resistance

GG: Plates made of Stainless Steel + rust resistance

Terminal screws captive and backed off ready for cabling - large angled terminal entries

Compact mechanism for maximum wiring space

Pack	Cat.Nos	Socket outlets 13 A - 250 V~
		Conform to BS 1363: Part. 2. With safety shutter mechanism For flush-mounting, back box to be min. 25 mm deep ASTA licence
		1 gang unswitched Nominal plate dimensions: 86 x 86 mm
1	8 330 65	● Brushed stainless steel
1	8 332 65	● Polished stainless steel
1	8 334 65	● Glossy gold
		2 gang unswitched Nominal plate dimensions: 86 x 146 mm
1	8 330 75	● Brushed stainless steel
1	8 332 75	● Polished stainless steel
1	8 334 75	● Glossy gold

Pack	Cat.Nos	Single pole socket outlets 13 A - 250 V~
		Conform to BS 1363: Part. 2. With safety shutter mechanism For flush-mounting, back box to be min. 25 mm deep ASTA licence
		1 gang switched Nominal plate dimensions: 86 x 86 mm
1	8 330 66	● Brushed stainless steel
1	8 332 66	● Polished stainless steel
1	8 334 66	● Glossy gold
		1 gang switched with blue LED power indicator Nominal plate dimensions: 86 x 86 mm
1	8 330 67	● Brushed stainless steel
1	8 332 67	● Polished stainless steel
1	8 334 67	● Glossy gold
		2 gang switched Nominal plate dimensions: 86 x 146 mm
1	8 330 76	● Brushed stainless steel
1	8 332 76	● Polished stainless steel
1	8 334 76	● Glossy gold
		2 gang switched with blue LED power indicator Nominal plate dimensions: 86 x 146 mm
1	8 330 77	● Brushed stainless steel
1	8 332 77	● Polished stainless steel
1	8 334 77	● Glossy gold

Pack	Cat.Nos	Double pole socket outlets 13 A - 250 V~
		Conform to BS 1363: Part. 2. With safety shutter mechanism For flush-mounting, back box to be min. 25 mm deep ASTA licence
		1 gang switched Nominal plate dimensions: 86 x 86 mm
1	8 330 60	● Brushed stainless steel
1	8 332 60	● Polished stainless steel
1	8 334 60	● Glossy gold
		1 gang switched with blue LED power indicator Nominal plate dimensions: 86 x 86 mm
1	8 330 61	● Brushed stainless steel
1	8 332 61	● Polished stainless steel
1	8 334 61	● Glossy gold
		2 gang switched Nominal plate dimensions: 86 x 146 mm
1	8 330 70	● Brushed stainless steel
1	8 332 70	● Polished stainless steel
1	8 334 70	● Glossy gold
		2 gang switched with blue LED power indicator Nominal plate dimensions: 86 x 146 mm
1	8 330 71	● Brushed stainless steel
1	8 332 71	● Polished stainless steel
1	8 334 71	● Glossy gold
		2 gang switched outboard for standard and clean earth applications Nominal plate dimensions: 86 x 146 mm
1	8 330 74	● Brushed stainless steel
1	8 332 74	● Polished stainless steel
1	8 334 74	● Glossy gold



8 332 97



8 334 89



8 330 69



8 332 59



8 330 44

Slim front plate:

BSS: Plates made of austenitic Stainless Steel - non-magnetic - grade 304 L

PSS: Plates made of Stainless Steel + rust resistance

GG: Plates made of Stainless Steel + rust resistance

Terminal screws captive and backed off ready for cabling - large angled terminal entries

Compact mechanism for maximum wiring space

Pack	Cat.Nos	RCD sockets 13 A - 250 V~
		Conform to BS 7288: 1990 and BS 1363 - Part 2: 1995 Conventional earth pin release shutter Maximum operating current 16 A Electronic RCD module with a membrane switch for "test and reset" Flush mounting back box : min. 25 mm deep
		ELO - DP 30 mA Trips in the event of a power failure Ideal for applications where it is desirable to prevent automatic reactivation of equipment after a power failure. For hazardous, e.g. machinery, power tools
1	8 330 85	1 gang - Nominal plate dimensions: 86 x 86 mm
1	8 332 85	● Brushed stainless steel
1	8 334 85	● Polished stainless steel
		● Glossy gold
1	8 330 97	2 gang - Nominal plate dimensions: 86 x 146 mm
1	8 332 97	● Brushed stainless steel
1	8 334 97	● Polished stainless steel
		● Glossy gold
		ELR - DP 30 mA Trips in the event of a power failure Ideal for applications where it is desirable to automatically re-activate equipment after a power failure. E.g. fridge, freezer, unmanned areas
		AVAILABLE JULY 2016
1	8 330 86	1 gang - Nominal plate dimensions: 86 x 86 mm
1	8 332 86	● Brushed stainless steel
1	8 334 86	● Polished stainless steel
		● Glossy gold
1	8 330 98	2 gang - Nominal plate dimensions: 86 x 146 mm
1	8 332 98	● Brushed stainless steel
1	8 334 98	● Polished stainless steel
		● Glossy gold
		Socket outlets 15 A - 250 V~
		Conform to BS 546 Patented 3 pin safety shutter mechanism, For flush-mounting, back box to be min. 35 mm deep Nominal plate dimensions: 86 x 86 mm
		1 gang unswitched
1	8 330 88	● Brushed stainless steel
1	8 332 88	● Polished stainless steel
1	8 334 88	● Glossy gold
		1 gang switched - single pole
1	8 330 89	● Brushed stainless steel
1	8 332 89	● Polished stainless steel
1	8 334 89	● Glossy gold

Pack	Cat.Nos	Socket outlets 15 A - 127 V~
		For flush-mounting, back box to be min. 35 mm deep
		1 gang Nominal plate dimensions: 86 x 86 mm
1	8 330 99	● Brushed stainless steel
1	8 334 99	● Polished stainless steel
1	8 333 99	● Glossy gold
		2 gang Nominal plate dimensions: 86 x 146 mm
1	8 332 99	● Brushed stainless steel
1	8 331 99	● Polished stainless steel
1	8 335 99	● Glossy gold
		Socket outlets 5 A - 250 V~
		Conform to BS 546 Patented 3 pin safety shutter mechanism, For flush-mounting, back box to be min. 25 mm deep
		1 gang unswitched Nominal plate dimensions: 86 x 86 mm
1	8 330 68	● Brushed stainless steel
1	8 332 68	● Polished stainless steel
1	8 334 68	● Glossy gold
		1 gang switched - single pole Nominal plate dimensions: 86 x 146 mm
1	8 330 69	● Brushed stainless steel
1	8 332 69	● Polished stainless steel
1	8 334 69	● Glossy gold
		Socket outlets 2 A - 250 V~
		Conform to BS 546 For flush-mounting, back box to be min. 25 mm deep Nominal plate dimensions: 86 x 86 mm
		1 gang unswitched
1	8 330 59	● Brushed stainless steel
1	8 332 59	● Polished stainless steel
1	8 334 59	● Glossy gold
		Double USB sockets
		For flush-mounting, back box to be min. 40 mm deep Input voltage: 110 V/ 230 V Comply with IEC 62684 5 V (output) - 2400 mA Wiring with 1.5 Sq.mm and 2.5 Sq.mm (only live and neutral)
1	8 330 44	● Brushed stainless steel
1	8 332 44	● Polished stainless steel
1	8 334 44	● Glossy gold

Synergy™ - cooker control units and fused connection units - Authentic



8 332 29

8 334 37

Slim front plate:

BSS: Plates made of austenitic Stainless Steel - non-magnetic - grade 304 L

PSS: Plates made of Stainless Steel + rust resistance

GG: Plates made of Stainless Steel + rust resistance

Terminal screws captive and backed off ready for cabling - large angled terminal entries. Compact mechanism for maximum wiring space

Pack	Cat.Nos	Cooker control units - 250 V~
		Conform to BS 4177: 1992 For flush-mounting, back box to be min. 47 mm deep Nominal plate dimensions: 86 x 146 mm
		45 A DP switch + 13 A DP switched socket outlet with blue LED power indicator
1	8 330 29	<ul style="list-style-type: none"> ● Brushed stainless steel ● Polished stainless steel ● Glossy gold
1	8 332 29	
1	8 334 29	
		Fused connection units 13 A - 250 V~
		Conform to BS 1363: Part. 4 Front cable outlet with cord grip Fuse supplied Locked captive fuse carrier (padlockable) For flush-mounting, back box to be min. 25 mm deep
		Unswitched with cord outlet
		Nominal plate dimensions: 86 x 86 mm
1	8 330 32	<ul style="list-style-type: none"> ● Brushed stainless steel ● Polished stainless steel ● Glossy gold
1	8 332 32	
1	8 334 32	
		Unswitched without cord outlet
		Nominal plate dimensions: 86 x 86 mm
1	8 330 30	<ul style="list-style-type: none"> ● Brushed stainless steel ● Polished stainless steel ● Glossy gold
1	8 332 30	
1	8 334 30	
		Unswitched with blue LED power indicator
		Nominal plate dimensions: 86 x 86 mm
1	8 330 31	<ul style="list-style-type: none"> ● Brushed stainless steel ● Polished stainless steel ● Glossy gold
1	8 332 31	
1	8 334 31	
		Unswitched with blue LED power indicator + cord outlet
		Nominal plate dimensions: 86 x 86 mm
1	8 330 33	<ul style="list-style-type: none"> ● Brushed stainless steel ● Polished stainless steel ● Glossy gold
1	8 332 33	
1	8 334 33	
		DP switched without cord outlet
		Nominal plate dimensions: 86 x 146 mm
1	8 330 34	<ul style="list-style-type: none"> ● Brushed stainless steel ● Polished stainless steel ● Glossy gold
1	8 332 34	
1	8 334 34	
		DP switched with blue LED power indicator
		Nominal plate dimensions: 86 x 146 mm
1	8 330 35	<ul style="list-style-type: none"> ● Brushed stainless steel ● Polished stainless steel ● Glossy gold
1	8 332 35	
1	8 334 35	
		DP switched with blue LED power indicator + cord outlet
		Nominal plate dimensions: 86 x 146 mm
1	8 330 37	<ul style="list-style-type: none"> ● Brushed stainless steel ● Polished stainless steel ● Glossy gold
1	8 332 37	
1	8 334 37	

Synergy™ - shaver sockets, cable outlets, blanking plates and cord outlets - Authentic



8 332 90

8 330 19

8 334 95

Slim front plates:

BSS: Plates made of austenitic Stainless Steel - non-magnetic - grade 304 L

PSS: Plates made of Stainless Steel + rust resistance

GG: Plates made of Stainless Steel + rust resistance

Terminal screws captive and backed off ready for cabling - large angled terminal entries. Compact mechanism for maximum wiring space

Pack	Cat.Nos	Shaver sockets
		Conform to BS EN 61558-2-5 Suitable for use with European, British and Australian 2 pin plugs Rating: 20 VA IP 24 Screwless live and neutral terminals For flush-mounting, back box to be min. 45 mm deep Nominal plate dimensions: 146 x 86 mm
		230/120 V~ - 50/60 Hz
1	8 330 90	<ul style="list-style-type: none"> ● Brushed stainless steel ● Polished stainless steel ● Glossy gold
1	8 332 90	
1	8 334 90	
		Cable outlets
		Conform to BS 5733 Fitted clamp and outlet membrane With terminal block Nominal plate dimensions: 86 x 86 mm
		20 A - 250 V~
1	8 330 19	<ul style="list-style-type: none"> ● Brushed stainless steel ● Polished stainless steel ● Glossy gold
1	8 332 19	
1	8 334 19	
		45 A - 250 V~
1	8 330 26	<ul style="list-style-type: none"> ● Brushed stainless steel ● Polished stainless steel ● Glossy gold
1	8 332 26	
1	8 334 26	
		Blanking plates
		1 gang
		Nominal plate dimensions: 86 x 86 mm
1	8 330 95	<ul style="list-style-type: none"> ● Brushed stainless steel ● Polished stainless steel ● Glossy gold
1	8 332 95	
1	8 334 95	
		2 gang
		Nominal plate dimensions: 86 x 146 mm
1	8 330 96	<ul style="list-style-type: none"> ● Brushed stainless steel ● Polished stainless steel ● Glossy gold
1	8 332 96	
1	8 334 96	
		Cord outlets
		1 gang
		Nominal plate dimensions: 86 x 86 mm
1	8 330 52	<ul style="list-style-type: none"> ● Brushed stainless steel ● Polished stainless steel ● Glossy gold
1	8 332 52	
1	8 334 52	



8 321 31



8 323 32



8 325 33



8 321 51



8 323 57



8 325 50

Sleek design

BSS: Plates made of austenitic Stainless Steel - non-magnetic - grade 304 L

PSS: Plates made of Stainless Steel + rust resistance

GG: Plates made of Stainless Steel + rust resistance

Terminal screws captive and backed off ready for cabling - large angled terminal entries

Compact mechanism for maximum wiring space

Pack	Cat.Nos	Single pole plate switches 10 AX - 250 V~
		Conform to BS EN 60669-1 For flush-mounting, back box to be min. 35 mm deep Nominal plate dimensions: 86 x 86 mm
1	8 320 01	1 gang - 2-way switch ● Brushed stainless steel ● Polished stainless steel ● Glossy gold
1	8 322 01	
1	8 324 01	
1	8 320 02	2 gang - 2-way switch ● Brushed stainless steel ● Polished stainless steel ● Glossy gold
1	8 322 02	
1	8 324 02	
		Single pole plate switches 20 AX - 250 V~
		Conform to BS EN 60669-1 For flush-mounting, back box to be min. 35 mm deep
1	8 321 31	1 gang - 2-way switch Nominal plate dimensions: 86 x 86 mm ● Brushed stainless steel ● Polished stainless steel ● Glossy gold
1	8 323 31	
1	8 325 31	
1	8 321 32	2 gang - 2-way switch Nominal plate dimensions: 86 x 86 mm ● Brushed stainless steel ● Polished stainless steel ● Glossy gold
1	8 323 32	
1	8 325 32	
1	8 321 33	3 gang - 2-way switch Nominal plate dimensions: 86 x 86 mm ● Brushed stainless steel ● Polished stainless steel ● Glossy gold
1	8 323 33	
1	8 325 33	
1	8 321 34	4 gang - 2-way switch Nominal plate dimensions: 86 x 146 mm ● Brushed stainless steel ● Polished stainless steel ● Glossy gold
1	8 323 34	
1	8 325 34	

Pack	Cat.Nos	Single pole intermediate 10 AX - 250 V~
		Conform to BS EN 60669-1 For flush-mounting, back box to be min. 35 mm deep
1	8 320 05	1 gang - 2-way switch ● Brushed stainless steel ● Polished stainless steel ● Glossy gold
1	8 322 05	
1	8 324 05	

Pack	Cat.Nos	Single pole push switches 10 A - 250 V~
		Conform to BS EN 60669-1 For flush-mounting, back box to be min. 35 mm deep Nominal plate dimensions: 86 x 86 mm
1	8 320 07	1 gang - 2-way push switch ● Brushed stainless steel ● Polished stainless steel ● Glossy gold
1	8 322 07	
1	8 324 07	

Pack	Cat.Nos	Push on/off rotary universal dimmers 5 W/300 W 100 - 240 V~ - 50/60 Hz
		Conform to IEC 60669-2-1 For flush-mounting back box to be min. 40 mm deep Equipped with overvoltage and short-circuit protection Screw terminals For all types of lamps: - dimmable LEDs: 5 W to 75 W - dimmable compact fluorescent lamps: 5 W to 75 W - halogen with ferromagnetic or electronic transformer: 5 VA to 300 VA - fluorescent tube - ballast: 5 VA to 300 VA - halogen and incandescent 230 V: 5 W to 300 W When switched on, gradually (2 seconds) lights up at the level set before last switch-off Nominal plate dimensions: 86 x 86 mm
1	8 321 51	1 gang - 2-way push switch ● Brushed stainless steel ● Polished stainless steel ● Glossy gold
1	8 323 51	
1	8 325 51	

Pack	Cat.Nos	Push on/off rotary dimmers 400 W 100 - 240 V~ - 50/60 Hz
		Conform to BS EN 60669-1 For flush-mounting, back box to be min. 35 mm deep Nominal plate dimensions: 86 x 86 mm
1	8 321 56	1 gang - 2 way ● Brushed stainless steel ● Polished stainless steel ● Glossy gold
1	8 323 56	
1	8 325 56	
1	8 321 57	2 gang - 2 way ● Brushed stainless steel ● Polished stainless steel ● Glossy gold
1	8 323 57	
1	8 325 57	

Pack	Cat.Nos	Push on/off rotary dimmers 1000 W 250 V~ - 50/60 Hz
		Conform to BS EN 60669-1 - For flush-mounting back box to be min. 40 mm deep - 60-1000 W (230 V) - 60-500 W (127 V) for incandescent and halogen lamps 60-600 VA (230 V) - 60-300 VA (127 V) for halogen lamps with electronic transformers 60-100 VA (230 V) - 60-500 VA (127 V) for halogen lamps with ferromagnetic transformers Nominal plate dimensions: 86 x 86 mm
1	8 321 50	1 gang - 2-way push switch ● Brushed stainless steel ● Polished stainless steel ● Glossy gold
1	8 323 50	
1	8 325 50	

Synergy™

double pole switches - Sleek Design



8 320 10



8 322 16



8 324 12



8 324 23

Sleek design

BSS: Plates made of austenitic Stainless Steel - non-magnetic - grade 304 L

PSS: Plates made of Stainless Steel + rust resistance

GG: Plates made of Stainless Steel + rust resistance

Terminal screws captive and backed off ready for cabling - large angled terminal entries

Compact mechanism for maximum wiring space

Pack	Cat.Nos	Double pole switches 20 A - 250 V~
		Conform to BS EN 60669-1 For flush-mounting, back box to be min. 35 mm deep Supplied with 1 gang side extension (3 mm thick) Cat.No 8 321 98 in case of extra wiring space needed Nominal plate dimensions: 86 x 86 mm
		DP switch
1	8 320 10	● Brushed stainless steel
1	8 322 10	● Polished stainless steel
1	8 324 10	● Glossy gold
		DP switch + cord outlet
1	8 320 16	● Brushed stainless steel
1	8 322 16	● Polished stainless steel
1	8 324 16	● Glossy gold
		DP switch + blue LED power indicator
1	8 320 12	● Brushed stainless steel
1	8 322 12	● Polished stainless steel
1	8 324 12	● Glossy gold

Pack	Cat.Nos	Double pole switches 45 A - 250 V~
		Conform to BS EN 60669-1 For flush-mounting, back box to be min. 47 mm deep Red rocker Nominal plate dimensions: 86 x 86 mm
		DP switch + blue LED power indicator
1	8 320 23	● Brushed stainless steel
1	8 322 23	● Polished stainless steel
1	8 324 23	● Glossy gold



Sleek design

BSS: Plates made of austenitic Stainless Steel - non-magnetic - grade 304 L

PSS: Plates made of Stainless Steel + rust resistance

GG: Plates made of Stainless Steel + rust resistance

Terminal screws captive and backed off ready for cabling - large angled terminal entries

Compact mechanism for maximum wiring space

Pack	Cat.Nos	Telephone sockets
		For flush-mounting, back box to be min. 35 mm deep Nominal plate dimensions: 86 x 86 mm
		UK master
1	8 320 50	● Brushed stainless steel
1	8 322 50	● Polished stainless steel
1	8 324 50	● Glossy gold
		UK secondary
1	8 320 51	● Brushed stainless steel
1	8 322 51	● Polished stainless steel
1	8 324 51	● Glossy gold
		RJ 11 / RJ 12 - single
1	8 320 54	● Brushed stainless steel
1	8 322 54	● Polished stainless steel
1	8 324 54	● Glossy gold

Pack	Cat.Nos	Data sockets Cat. 6
		Rapid cable connection For flush-mounting, back box to be min. 35 mm deep Nominal plate dimensions: 86 x 86 mm
		RJ 45 - single
1	8 320 56	● Brushed stainless steel
1	8 322 56	● Polished stainless steel
1	8 324 56	● Glossy gold
		RJ 45 - twin
1	8 320 57	● Brushed stainless steel
1	8 322 57	● Polished stainless steel
1	8 324 57	● Glossy gold

Pack	Cat.Nos	Television sockets
		For flush-mounting, back box to be min. 35 mm deep Screened Nominal plate dimensions: 86 x 86 mm
		TV sockets - single male
1	8 320 40	● Brushed stainless steel
1	8 322 40	● Polished stainless steel
1	8 324 40	● Glossy gold
		SAT sockets - single "F" type
1	8 320 41	● Brushed stainless steel
1	8 322 41	● Polished stainless steel
1	8 324 41	● Glossy gold
		TV-R-SAT sockets - "F" type
1	8 320 43	● Brushed stainless steel
1	8 322 43	● Polished stainless steel
1	8 324 43	● Glossy gold

Synergy™

British standard socket outlets and USB socket - Sleek Design



8 320 75



8 322 61



8 324 89



8 322 59



8 320 44

Sleek design

BSS: Plates made of austenitic Stainless Steel - non-magnetic - grade 304 L

PSS: Plates made of Stainless Steel + rust resistance

GG: Plates made of Stainless Steel + rust resistance

Terminal screws captive and backed off ready for cabling - large angled terminal entries

Compact mechanism for maximum wiring space

Pack	Cat.Nos	Socket outlets 13 A - 250 V~
		Conform to BS EN 1363: Part. 2 With safety shutter mechanism For flush-mounting, back box to be min. 35 mm deep ASTA licence
		1 gang unswitched Nominal plate dimensions: 86 x 86 mm
1	8 320 65	● Brushed stainless steel
1	8 322 65	● Polished stainless steel
1	8 324 65	● Glossy gold
		2 gang unswitched Nominal plate dimensions: 86 x 146 mm
1	8 320 75	● Brushed stainless steel
1	8 322 75	● Polished stainless steel
1	8 324 75	● Glossy gold

Pack	Cat.Nos	Single pole socket outlets 13 A - 250 V~
		Conform to BS EN 1363: Part. 2 With safety shutter mechanism For flush-mounting, back box to be min. 35 mm deep ASTA licence
		1 gang switched Nominal plate dimensions: 86 x 86 mm
1	8 320 66	● Brushed stainless steel
1	8 322 66	● Polished stainless steel
1	8 324 66	● Glossy gold
		1 gang switched with blue LED power indicator Nominal plate dimensions: 86 x 86 mm
1	8 320 67	● Brushed stainless steel
1	8 322 67	● Polished stainless steel
1	8 324 67	● Glossy gold
		2 gang switched Nominal plate dimensions: 86 x 146 mm
1	8 320 76	● Brushed stainless steel
1	8 322 76	● Polished stainless steel
1	8 324 76	● Glossy gold
		2 gang switched with blue LED power indicator Nominal plate dimensions: 86 x 146 mm
1	8 320 77	● Brushed stainless steel
1	8 322 77	● Polished stainless steel
1	8 324 77	● Glossy gold

Pack	Cat.Nos	Double pole socket outlets 13 A - 250 V~
		Conform to BS EN 1363: Part. 2 With safety shutter mechanism For flush-mounting, back box to be min. 35 mm deep Nominal plate dimensions: 86 x 86 mm ASTA licence
		1 gang switched
1	8 320 60	● Brushed stainless steel
1	8 322 60	● Polished stainless steel
1	8 324 60	● Glossy gold
		1 gang switched with blue LED power indicator
1	8 320 61	● Brushed stainless steel
1	8 322 61	● Polished stainless steel
1	8 324 61	● Glossy gold

Pack	Cat.Nos	Double pole socket outlets 13 A - 250 V~ (continued)
		Conform to BS EN 1363: Part. 2 With safety shutter mechanism For flush-mounting, back box to be min. 35 mm deep Nominal plate dimensions: 86 x 146 mm ASTA licence
		2 gang switched
1	8 320 70	● Brushed stainless steel
1	8 322 70	● Polished stainless steel
1	8 324 70	● Glossy gold
		2 gang switched with blue LED power indicator
1	8 320 71	● Brushed stainless steel
1	8 322 71	● Polished stainless steel
1	8 324 71	● Glossy gold

Pack	Cat.Nos	Socket outlets 15 A - 250 V~
		Conform to BS 546 Patented 3 pin safety shutter mechanism For flush-mounting, back box to be min. 35 mm deep Nominal plate dimensions: 86 x 86 mm
		1 gang switched
1	8 320 89	● Brushed stainless steel
1	8 322 89	● Polished stainless steel
1	8 324 89	● Glossy gold

Pack	Cat.Nos	Socket outlets 5 A - 250 V~
		Conform to BS 546 Patented 3 pin safety shutter mechanism For flush-mounting, back box to be min. 25 mm deep Nominal plate dimensions: 86 x 86 mm
		1 gang switched - single pole
1	8 320 69	● Brushed stainless steel
1	8 322 69	● Polished stainless steel
1	8 324 69	● Glossy gold

Pack	Cat.Nos	Socket outlets 2 A - 250 V~
		Conform to BS 546 For flush-mounting, back box to be min. 25 mm deep Nominal plate dimensions: 86 x 86 mm
		1 gang unswitched
1	8 320 59	● Brushed stainless steel
1	8 322 59	● Polished stainless steel
1	8 324 59	● Glossy gold

Pack	Cat.Nos	Double USB socket
		Conform to IEC 62684 For flush-mounting, back box to be min. 40 mm deep Input voltage: 110 V/ 230 V 5 V (output) - 2400 mA Wiring with 1.5 Sq.mm and 2.5 Sq.mm (only live and neutral)
		Double USB socket
1	8 320 44	● Brushed stainless steel
1	8 322 44	● Polished stainless steel
1	8 324 44	● Glossy gold

Synergy™ - cooker control units, fused connection units and cable outlets - Sleek Design



8 320 32

8 322 37

8 324 19

Sleek design

BSS: Plates made of austenitic Stainless Steel - non-magnetic - grade 304 L

PSS: Plates made of Stainless Steel + rust resistance

GG: Plates made of Stainless Steel + rust resistance

Terminal screws captive and backed off ready for cabling - large angled terminal entries

Compact mechanism for maximum wiring space

Pack	Cat.Nos	Cooker control units - 250 V~
		Conform to BS 4177: 1992 For flush-mounting, back box to be min 47 mm deep Nominal plate dimensions: 86 x 146 mm
1	8 320 29	45 A DP switch + 13 A DP switched socket outlet - with blue LED power indicator <ul style="list-style-type: none"> ● Brushed stainless steel ● Polished stainless steel ● Glossy gold
1	8 322 29	
1	8 324 29	

		Fused connection units unswitched 13 A - 250 V~ Conform to BS 1363: Part. 4. Front cable outlet with cord grip. Fuses supplied. Locked captive fuse carrier (padlockable). For flush-mounting, back box to be min. 35 mm deep. Supplied with 1 gang side extension Cat.No 8 321 98 (3 mm thick) in case of extra wiring space needed Nominal plate dimensions: 86 x 86 mm
1	8 320 32	Unswitched - with cord outlet <ul style="list-style-type: none"> ● Brushed stainless steel ● Polished stainless steel ● Glossy gold
1	8 322 32	
1	8 324 32	

		Fused connection units switched 13 A - 250 V~ Conform to BS 1363: Part. 4. Front cable outlet with cord grip. Fuses supplied. Locked captive fuse carrier (padlockable). For flush-mounting, back box to be min. 35 mm deep. Supplied with 1 gang side extension Cat.No 8 321 98 (3 mm thick) in case of extra wiring space needed Nominal plate dimensions: 86 x 86 mm
1	8 320 35	DP switched - without cord outlet <ul style="list-style-type: none"> ● Brushed stainless steel ● Polished stainless steel ● Glossy gold
1	8 322 35	
1	8 324 35	
1	8 320 37	DP switched - with blue LED power indicator + cord outlet <ul style="list-style-type: none"> ● Brushed stainless steel ● Polished stainless steel ● Glossy gold
1	8 322 37	
1	8 324 37	

		Cable outlets Conform to BS 5733. Fitted with clamp and outlet membrane. With terminal block Nominal plate dimensions: 86 x 86 mm
1	8 320 19	20 A - 250 V~ <ul style="list-style-type: none"> ● Brushed stainless steel ● Polished stainless steel ● Glossy gold
1	8 322 19	
1	8 324 19	
1	8 320 26	45 A - 250 V~ <ul style="list-style-type: none"> ● Anthracite grey colour (plastic)

Synergy™ hotel equipment - Sleek Design



8 320 90

8 323 00

8 325 01

Sleek design

BSS: Plates made of austenitic Stainless Steel - non-magnetic - grade 304 L

PSS: Plates made of Stainless Steel + rust resistance

GG: Plates made of Stainless Steel + rust resistance

Terminal screws captive and backed off ready for cabling - large angled terminal entries

Compact mechanism for maximum wiring space

Pack	Cat.Nos	Shaver sockets
		Conform to BS EN 61558-2-5 Suitable for use with European, British, American and Australian 2 pin plugs. Rating: 20 VA. IP 24 Screwless live and neutral terminals For flush-mounting, back box to be min. 45 mm deep Supplied with 2 gang side extension Cat.No 8 321 99 (3 mm thick) in case of extra wiring space needed Nominal plate dimensions: 146 x 86 mm
1	8 320 90	230 V / 120 V - 50/60 Hz <ul style="list-style-type: none"> ● Brushed stainless steel ● Polished stainless steel ● Glossy gold
1	8 322 90	
1	8 324 90	

		Key card switch 230 V For energizing a circuit by inserting a key fob or a smart card (access card for a hotel room) Example of use: hotel room power supply only when guest is present Time delay of approx. 30 sec. after card removal To be equipped with a single pole latching relay or contactor
1	8 321 00	<ul style="list-style-type: none"> ● Brushed stainless steel ● Polished stainless steel ● Glossy gold
1	8 323 00	
1	8 325 00	

		Hotel call indicator DND/Please clean up Indicator for corridor Indicator lamp and bell push Installed in the corridor, displays calls
1	8 321 01	<ul style="list-style-type: none"> ● Brushed stainless steel ● Polished stainless steel ● Glossy gold
1	8 323 01	
1	8 325 01	

		Hotel call indicator - internal room control Internal Control Unit Allows the user to select the desired setting Supplied with LED
1	8 321 02	<ul style="list-style-type: none"> ● Brushed stainless steel ● Polished stainless steel ● Glossy gold
1	8 323 02	
1	8 325 02	

Synergy™

blanking plates, cord outlets - Sleek Design



8 320 95



8 322 96



8 320 52

Sleek design

BSS: Plates made of austenitic Stainless Steel - non-magnetic - grade 304 L

PSS: Plates made of Stainless Steel + rust resistance

GG: Plates made of Stainless Steel + rust resistance

Terminal screws captive and backed off ready for cabling - large angled terminal entries

Pack	Cat.Nos	Blanking plates	
		1 gang	
		Nominal plate dimensions: 86 x 86 mm	
1	8 320 95	<ul style="list-style-type: none"> ● Brushed stainless steel ● Polished stainless steel ● Glossy gold 	
1	8 322 95		
1	8 324 95		
		2 gang	
		Nominal plate dimensions: 86 x 146 mm	
1	8 320 96	<ul style="list-style-type: none"> ● Brushed stainless steel ● Polished stainless steel ● Glossy gold 	
1	8 322 96		
1	8 324 96		
		Cord outlets	
		1 gang	
		Nominal plate dimensions: 86 x 86 mm	
1	8 320 52	<ul style="list-style-type: none"> ● Brushed stainless steel ● Polished stainless steel ● Glossy gold 	
1	8 322 52		
1	8 324 52		

SYNERGY™

New Packaging Versatile & Practical



Suitable for product display on hooks

Can easily be stocked in shelf racks.

Transparent cover for easy identification of the finish. Highlights the quality of the product.

Informative and clear label.



Front plates: grey epoxy coated steel
Terminal screws captive and backed off ready for cabling - large angled terminal entries
Supplied complete with close fit 43 mm deep surface-mounting back box













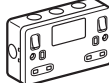





Pack	Cat.Nos	Single pole plate switches 10 AX - 250 V~	Pack	Cat.Nos	Television sockets	
5	7 338 00	Conform to BS EN 60669-1: 2000 Flush-mounting back box: min. 16 mm deep Nominal plate dimensions: 86 x 86 mm 1 gang - 1-way	5	7 338 40	Flush-mounting back box: min. 35 mm deep Nominal plate dimensions: 86 x 86 mm Screened TV - single, male	
5	7 338 01		1	7 338 41	Screened satellite - single, "F" type	
5	7 338 05		1 gang - 2-way			
5	7 338 02	1 gang - intermediate				
5	7 338 02	2 gang - 2-way				
5	7 338 03	2 gang - 2-way				
5	7 338 03	3 gang - 2-way				
Pack	Cat.Nos	Double pole switches 20 A - 250 V~	Pack	Cat.Nos	Telephone sockets	
5	7 338 10	Conform to BS EN 60669-1: 2000 Flush-mounting back box: min. 25 mm deep Nominal plate dimensions: 86 x 86 mm DP switch	5	7 338 50	Flush-mounting back box: min. 35 mm deep Nominal plate dimensions: 86 x 86 mm Single master	
5	7 338 16		DP switch with cord outlet + red LED power indicator	5	7 338 51	Single secondary
5	7 338 12		DP switch + red LED power indicator			
Pack	Cat.Nos	Double pole switch 45 A - 250 V~	Pack	Cat.Nos	Data sockets Cat. 6	
5	7 338 21	Conforms to BS EN 60669-1: 2000 Red rocker Flush-mounting back box: min. 48 mm deep Nominal plate dimensions: 146 x 86 mm DP switch + red power indicator	1	7 338 56	Rapid cable connection Flush-mounting back box: min. 35 mm deep Nominal plate dimensions: 86 x 86 mm RJ 45 - single	
				1	7 338 57	RJ 45 - twin
Pack	Cat.Nos	Blanking plates	Pack	Cat.Nos	Cable outlet 20 A - 250 V~	
5	7 338 95	1 gang Nominal plate dimensions: 86 x 86 mm	5	7 338 19	Conforms to BS 5733: 1995 Flush-mounting back box: min. 25 mm deep Nominal plate dimensions: 86 x 86 mm 20 A - with terminal block and outlet gland	
5	7 338 96	2 gang Nominal plate dimensions: 86 x 146 mm				

Synergy™

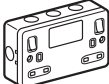
British standard socket outlets, RCD sockets and fused connection units - Metalclad



Front plates: grey epoxy coated steel. Terminal screws captive and backed off ready for cabling - large angled terminal entries
 Supplied complete with close fit 43 mm deep surface-mounting back box

Pack	Cat.Nos	Socket outlets 13 A - 250 V~	Pack	Cat.Nos	RCD sockets 13 A - 250 V~ (continued)
5	7 338 65	Conform to BS 1363 - Part 2: 1995 With safety shutter mechanism Flush-mounting back box: min. 25 mm deep 1 gang - unswitched Nominal plate dimensions: 86 x 86 mm 	1	7 338 81	ELR - DP 30 mA Trips in the event of a power failure Ideal for applications where it is desirable to automatically re-activate equipment after a power failure. E.g. fridge, freezer, unmanned areas 1 gang Nominal plate dimensions: 86 x 86 mm 
5	7 338 75	2 gang - unswitched Nominal plate dimensions: 86 x 146 mm 	1	7 338 83	2 gang Nominal plate dimensions: 86 x 146 mm 
5	7 338 60	Double pole socket outlets 13 A - 250 V~ Conform to BS 1363 - Part 2: 1995 With safety shutter mechanism Flush-mounting back box: min. 25 mm deep Switched 1 gang Nominal plate dimensions: 86 x 86 mm 	5	7 338 88	Socket outlets 15 A - 250 V~ Conform to BS 546: 1950 Patented 3 pin safety shutter mechanism Flush-mounting back box: min. 35 mm deep Nominal plate dimensions: 86 x 86 mm 1 gang - unswitched 
5	7 338 70	2 gang Nominal plate dimensions: 86 x 146 mm 	5	7 338 89	1 gang - switched 
5	7 338 61	Switched with red LED power indicator 1 gang Nominal plate dimensions: 86 x 86 mm 	5	7 338 34	Fused connection units 13 A - 250 V~ Conform to BS 1363 - Part 4: 1995. Fused 13 A (fuse supplied). Fuse drawer retained by quarter turn catch, drawer padlockable in open position for safety. Flush-mounting back box: min. 25 mm deep Nominal plate dimensions: 86 x 86 mm Double pole switched Without cord outlet 
5	7 338 71	2 gang Nominal plate dimensions: 86 x 146 mm 	5	7 338 35	With red LED power indicator 
1	7 338 80	RCD sockets 13 A - 250 V~ Conform to BS 7288: 1990 and BS 1363 - Part 2: 1995 Conventional earth pin release shutter Maximum operating current 16 A Electronic RCD module with a membrane switch for "test and reset" Flush mounting back box : min. 25 mm deep ELO - DP 30 mA Trips in the event of a power failure Ideal for applications where it is desirable to prevent automatic reactivation of equipment after a power failure. For hazardous, e.g. machinery, power tools 1 gang Nominal plate dimensions: 86 x 86 mm 	5	7 338 36	With cord outlet 
1	7 338 82	2 gang Nominal plate dimensions: 86 x 146 mm 	5	7 338 37	With cord outlet + red LED power indicator 
			5	7 338 30	Unswitched Without cord outlet 
			5	7 338 31	With red LED power indicator 
			5	7 338 32	With cord outlet 
			5	7 338 33	With cord outlet + red LED power indicator 

Grid System

Multiple functions
One control point



Synergy™

Grid modules - decorative rockers



8 326 00

8 326 06

8 326 12



Front plate selection charts p. 44-45



- A perfect blend of style and versatility.
- Grid plates available in all sizes from 1 to 24 gang.

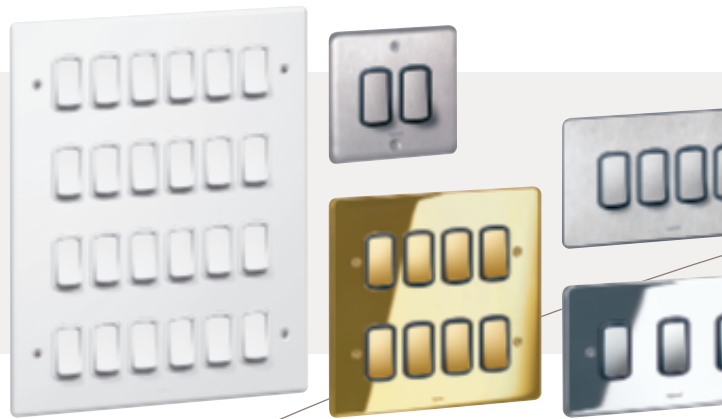

- Switch modules available in five finishes.



Single pole switches 10 AX - 250 V~

Pack	Cat.Nos	
1	8 326 00	1-way switch
1	8 326 06	● Brushed stainless steel
1	8 326 12	● Polished stainless steel
		● Glossy gold
1	8 326 01	2-way switch
1	8 326 07	● Brushed stainless steel
1	8 326 13	● Polished stainless steel
		● Glossy gold
1	8 326 02	Intermediate switch
1	8 326 08	● Brushed stainless steel
1	8 326 14	● Polished stainless steel
		● Glossy gold

Single pole switches 20 AX - 250 V~

1	8 326 03	1-way switch
1	8 326 09	● Brushed stainless steel
1	8 326 15	● Polished stainless steel
		● Glossy gold
1	8 326 04	2-way switch
1	8 326 10	● Brushed stainless steel
1	8 326 16	● Polished stainless steel
		● Glossy gold
1	8 326 05	2-way retractive centre off switch
1	8 326 11	● Brushed stainless steel
1	8 326 17	● Polished stainless steel
		● Glossy gold

Synergy™

Grid modules - white and anthracite rockers without marking



Front plate selection charts p. 44-45

Pack	Cat.Nos		
	White	Anthracite	
10	7 354 00	7 355 00	Single pole switches 10 AX - 250 V~
10	7 354 01	7 355 01	Conform to BS EN 60669-1 1 way
10	7 354 03	7 355 03	1 way + neon
10	7 354 07	7 355 07	2 way
10	7 354 05	7 355 05	Intermediate
10	7 354 06	7 355 06	2-way push switch
10	7 354 06	7 355 06	2-way push switch marked "BELL"

Pack	Cat.Nos		
	White	Anthracite	
10	7 354 10	7 355 10	Single pole switches 20 AX - 250 V~
10	7 354 11	7 355 11	Conform to BS EN 60669-1 1 way
10	7 354 12	7 355 12	1 way + neon
10	7 354 18	7 355 18	2 way
10	7 354 13	7 355 13	Intermediate
10	7 354 14	7 355 14	2-way centre off
10	7 354 15	7 355 15	2-way retractive centre off
10	7 354 15	7 355 15	2-way push switch

Pack	Cat.Nos		
	White	Anthracite	
10	7 354 16	7 355 16	Single pole key switches 20 AX - 250 V~
10	7 354 17	7 355 17	Conform to BS EN 60669-1 Key supplied
			2-way
			2-way retractive centre off

Pack	Cat.Nos		
	White	Anthracite	
10	7 354 20	7 355 20	Double pole switches 20 AX - 250 V~
10	7 354 21	7 355 21	Conform to BS EN 60669-1 Switch
10	7 354 22	7 355 22	Switch + neon
10	7 354 25	7 355 25	Push to make
10	7 354 25	7 355 25	Push to break

Pack	Cat.Nos		
	White	Anthracite	
10	7 354 23	7 355 23	Double pole key switches 20 AX - 250 V~
10	7 354 24	7 355 24	Conform to BS EN 60669-1 Key supplied
			Key switch
			Key switch + neon

Pack	Cat.Nos		
	White	Anthracite	
1	7 354 46	7 355 46	Dimmers 100 - 240 V~ - 50-60 Hz
1	7 354 48	7 355 48	Conform to BS EN 60669-2-1 2-way - 300 W - push dimmer
			2-way rotary dimmer - for 0-10 V ballasts - 400 W

Pack	Cat.Nos		
	White	Anthracite	
1	7 354 47	7 355 47	Time delay switches
			Time delay switch 300 W

Pack	Cat.Nos		
	White	Anthracite	
1	7 354 50	7 355 50	Telephone sockets
1	7 354 51	7 355 51	BT master
			BT secondary

Pack	Cat.Nos		
	White	Anthracite	
10	7 352 56	7 353 56	Data sockets - Cat. 6
			RJ 45 - 8 contacts

Pack	Cat.Nos		
	White	Anthracite	
10	7 354 40	7 355 40	Television sockets
10	7 354 41	7 355 41	Screened TV single, male
			Screened TV-SAT

Pack	Cat.Nos		
	White	Anthracite	
10	7 352 65	7 353 65	Loudspeaker sockets
			Hi-Fi loudspeaker socket

Pack	Cat.Nos		
	White	Anthracite	
10	7 350 30	7 351 30	Fuse carriers 13 A - 250 V~
			Fuse carrier

Pack	Cat.Nos		
	White	Anthracite	
10	7 350 62	7 351 62	Accessories
10	7 350 60	7 351 60	Indicator - green neon
20	7 354 36	7 355 36	Indicator - red neon
			Blanking plate

GRID MODULES	ARCHITRAVES		FRONT PLATES WITH SMALL APERTURES			
	1 gang	2 gang	1 gang		2 gang	
	1 module	2 modules	1 module	2 modules	3 modules	4 modules
Dimensions (mm)	86 x 36	146 x 36	86 x 86	86 x 86	86 x 146	86 x 146
White	7 301 80	7 301 81	7 301 91	7 301 92	7 301 93	7 301 94
Authentic Brushed stainless steel	8 331 80	8 331 81	8 331 91	8 331 92	8 331 93	8 331 94
Authentic Polished stainless steel	8 333 80	8 333 81	8 333 91	8 333 92	8 333 93	8 333 94
Authentic Glossy gold	8 335 80	8 335 81	8 335 91	8 335 92	8 335 93	8 335 94
Sleek Design Brushed stainless steel	-	-	8 321 91 ⁽¹⁾	8 321 92 ⁽¹⁾	8 321 93 ⁽¹⁾	8 321 94 ⁽¹⁾
Sleek Design Polished stainless steel	-	-	8 323 91 ⁽¹⁾	8 323 92 ⁽¹⁾	8 323 93 ⁽¹⁾	8 323 94 ⁽¹⁾
Sleek Design Glossy gold	-	-	8 325 91	8 325 92	8 325 93	8 325 94
Metalclad	-	-	7 339 91	7 339 92	7 339 93	7 339 94
GRID YOKES						
For White, Authentic, Sleek Design and Metalclad	1 x 7 354 95	1 x 7 354 96	1 x 7 354 90	1 x 7 354 91	1 x 7 354 92	1 x 7 354 92
BOXES						
Flush-mounting	-	-	-	-	-	-
Flush-mounting with phase barriers	-	-	-	-	-	-
Surface-mounting, steel with knockouts	-	-	-	-	-	-
Surface-mounting, steel without knockouts	-	-	-	-	-	-
Surface-mounting, metal with knockouts	-	-	7 364 00	7 364 00	7 364 01	7 364 01

Example of association:



1: Yokes supplied with front plate

FRONT PLATES WITH SMALL APERTURES

2 x 2 gang		3 x 2 gang		3 x 3 gang	4 x 3 gang
6 modules	8 modules	9 modules	12 modules	18 modules	24 modules
					
146 x 146	146 x 146	207 x 146	207 x 146	267 x 206	267 x 206
7 301 82	7 301 83	7 301 84	7 301 85	7 301 86	7 301 87
8 331 82	8 331 83	8 331 84	8 331 85	8 331 86	8 331 87
8 333 82	8 333 83	8 333 84	8 333 85	8 333 86	8 333 87
8 335 82	8 335 83	8 335 84	8 335 85	8 335 86	8 335 87
8 321 95 ⁽¹⁾	8 321 96 ⁽¹⁾	-	-	-	-
8 323 95 ⁽¹⁾	8 323 96 ⁽¹⁾	-	-	-	-
8 325 95	8 325 96	-	-	-	-
7 339 82	7 339 83	7 339 84	7 339 85	7 339 86	7 339 87
					
2 x 7 354 92	2 x 7 354 92	3 x 7 354 92	3 x 7 354 92	3 x 7 354 93	4 x 7 354 93
0 818 52	0 818 52	0 818 53	0 818 53	0 818 54	0 818 55
-	-	0 818 57	0 818 57	-	-
7 364 18	7 364 18	7 364 28	7 364 28	-	-
7 364 22	7 364 22	7 364 32	7 364 32	-	-
-	-	-	-	-	-

GRID SYSTEM	FRONT PLATES FOR ARTEOR MECHANISMS					
	1 gang for 1 Arteor module	1 gang for 2 Arteor modules	2 gang for 3 Arteor modules	2 gang for 4 Arteor modules	2 x 2 gang for 8 Arteor modules	3 x 3 gang for 18 Arteor modules
FRONT PLATES	Clip-in carrier plate - No yoke required				Yoke required	
Dimensions (mm)	86 x 86	86 x 86	86 x 146	86 x 146	146 x 146	267 x 207
White ○	7 300 91	7 300 92	7 300 93	7 300 94	7 301 88	7 301 90
Authentic Brushed stainless steel ●	8 330 91	8 330 92	8 330 93	8 330 94	8 331 88	8 331 90
Authentic Polished stainless steel ●	8 332 91	8 332 92	8 332 93	8 332 94	8 333 88	8 333 90
Authentic Glossy gold ●	8 334 91	8 334 92	8 334 93	8 334 94	8 335 88	8 335 90
Sleek Design Brushed stainless steel ●	8 320 91	8 320 92	8 320 93	8 320 94	-	-
Sleek Design Polished stainless steel ●	8 322 91	8 322 92	8 322 93	8 322 94	-	-
Sleek Design Glossy gold ●	8 324 91	8 324 92	8 324 93	8 324 94	-	-
Metalclad ●	7 338 91 ⁽¹⁾	7 338 92 ⁽¹⁾	7 338 93 ⁽¹⁾	7 338 94 ⁽¹⁾	-	-
GRID YOKES	No yoke required					
Grid yokes					2 x 7 354 74	3 x 7 354 76

Examples with Arteor mechanisms



1: Supplied with back box

Catalogue number index

Cat.Nos	Page No	Pack	Cat.Nos	Page No	Pack	Cat.Nos	Page No	Pack	Cat.Nos	Page No	Pack
6 780 00			7 301 30	23	10	7 354 10	43	10	8 320 51	36	1
6 781 33	25	1	31	-	10	11	-	10	52	39	1
34	-	1	32	-	10	12	-	10	54	36	1
37	-	1	33	-	10	13	-	10	56	-	1
38	-	1	34	-	10	14	-	10	57	-	1
			35	-	10	15	-	10	59	37	1
7 300 00			40	24	10	16	-	10	60	-	1
7 300 00	23	10	41	-	1	17	-	10	61	-	1
01	-	10	44	-	10	18	-	10	65	-	1
02	-	10	45	-	10	20	-	10	66	-	1
03	-	10	50	23	1	21	-	10	67	-	1
04	-	5	56	-	1	22	-	10	69	-	1
05	-	10	57	-	1	23	-	10	70	-	1
06	-	5	58	27	10	24	-	10	71	-	1
07	-	5	61	25	5	25	-	10	75	-	1
08	-	10	62	-	10	36	-	20	76	-	1
09	-	10	7 310 00			40	-	10	77	-	1
10	24	10	7 311 51	23	1	41	-	10	89	-	1
11	23	5	7 330 00			46	-	1	90	38	1
12	24	10	7 338 00	40	5	47	-	1	95	39	1
19	27	10	01	-	5	48	-	1	96	-	1
20	24	5	02	-	5	50	-	1			
21	-	5	03	-	5	51	-	1	8 321 00	38	1
22	-	10	05	-	5				01	-	1
23	-	10	10	-	5	7 355 00	43	10	02	-	1
24	23	10	12	-	5	01	-	10	31	34	1
26	27	5	16	-	5	03	-	10	32	-	1
28	-	5	19	-	5	05	-	10	33	-	1
29	-	5	21	-	5	06	-	10	34	-	1
32	-	10	30	41	5	07	-	10	50	-	1
33	-	10	31	-	5	10	-	10	51	-	1
36	-	10	32	-	5	11	-	10	56	-	1
37	-	10	33	-	5	12	-	10	57	-	1
40	24	10	34	-	5	13	-	10			
41	-	1	35	-	5	14	-	10	8 322 01	34	1
43	-	1	36	-	5	15	-	10	02	-	1
49	23	1	37	-	5	16	-	10	05	-	1
50	24	10	40	40	5	17	-	10	07	-	1
51	-	10	41	-	1	18	-	10	10	35	1
53	27	10	50	-	5	20	-	10	12	-	1
54	24	10	51	-	5	21	-	10	16	-	1
56	-	1	56	-	1	22	-	10	19	38	1
57	-	1	57	-	1	23	-	10	23	35	1
58	27	10	60	41	5	24	-	10	29	38	1
59	26	10	61	-	5	25	-	10	32	-	1
60	25	10	65	-	5	36	-	20	35	-	1
61	-	10	70	-	5	40	-	10	37	-	1
64	-	10	71	-	5	41	-	10	40	36	1
65	-	10	75	-	5	46	-	1	41	-	1
66	-	10	80	-	1	47	-	1	43	-	1
67	-	10	81	-	1	48	-	1	44	37	1
68	26	10	82	-	1	50	-	1	50	36	1
69	-	10	83	-	1	51	-	1	51	-	1
70	25	5	88	-	5	7 360 00			52	39	1
71	-	5	89	-	5	7 364 06	27	10	54	36	1
74	-	5	95	40	5	07	-	10	56	-	1
75	-	5	96	-	5	10	-	5	57	-	1
76	-	5	7 350 00			11	-	5	59	37	1
77	-	5	7 350 30	43	10	13	-	5	60	-	1
80	26	10	60	-	10	8 320 00			61	-	1
81	-	10	62	-	10	8 320 01	34	1	65	-	1
82	-	10				02	-	1	66	-	1
83	-	10	7 351 30	43	10	05	-	1	67	-	1
84	-	10	60	-	10	07	-	1	69	-	1
85	-	5	62	-	10	10	35	1	70	-	1
86	-	5				12	-	1	71	-	1
88	-	10	7 352 56	43	10	16	-	1	75	-	1
89	-	10	65	-	10	19	38	1	76	-	1
90	-	1				23	35	1	77	-	1
95	27	10	7 353 56	43	10	26	38	1	89	-	1
96	-	10	65	-	10	29	-	1	90	38	1
99	24	10				32	-	1	95	39	1
			7 354 00	43	10	35	-	1	96	-	1
7 301 00	24	10	01	-	10	37	-	1			
07	23	5	03	-	10	40	36	1	8 323 00	38	1
10	24	10	05	-	10	41	-	1	01	-	1
12	-	10	06	-	10	43	-	1	02	-	1
20	-	5	07	-	10	44	37	1	31	34	1
22	-	10				50	36	1	32	-	1
24	23	10							33	-	1
									34	-	1

Catalogue number index

Cat.Nos	Page No	Pack	Cat.Nos	Page No	Pack	Cat.Nos	Page No	Pack	Cat.Nos	Page No	Pack
8 323 50	34	1	8 330 04	28	1	8 332 30	33	1	8 334 52	33	1
51	-	1	05	-	1	31	-	1	54	30	1
56	-	1	07	-	1	32	-	1	56	-	1
57	-	1	09	29	1	33	-	1	57	30	1
			10	-	1	34	-	1	59	32	1
8 324 01	34	1	12	-	1	35	-	1	60	31	1
02	-	1	16	-	1	37	-	1	61	-	1
05	-	1	19	33	1	40	30	1	65	-	1
07	-	1	21	29	1	41	-	1	66	-	1
10	35	1	22	-	1	43	-	1	67	-	1
12	-	1	23	-	1	44	32	1	68	32	1
16	-	1	26	33	1	50	30	1	69	-	1
19	38	1	29	-	1	51	-	1	70	31	1
23	35	1	30	-	1	52	33	1	71	-	1
29	38	1	31	-	1	54	30	1	74	-	1
32	-	1	32	-	1	56	-	1	75	-	1
35	-	1	33	-	1	57	-	1	76	-	1
37	-	1	34	-	1	59	32	1	77	-	1
40	36	1	35	-	1	60	31	1	85	32	1
41	-	1	37	-	1	61	-	1	86	-	1
43	-	1	40	30	1	65	-	1	88	-	1
44	37	1	41	-	1	66	-	1	89	-	1
50	36	1	43	-	1	67	-	1	90	33	1
51	-	1	44	32	1	68	32	1	95	-	1
52	39	1	50	30	1	69	-	1	96	-	1
54	36	1	51	-	1	70	31	1	97	32	1
56	-	1	52	33	1	71	-	1	98	-	1
57	-	1	54	30	1	74	-	1	99	-	1
59	37	1	56	-	1	75	-	1			
60	-	1	57	-	1	76	-	1	8 335 31	28	1
61	-	1	59	32	1	77	-	1	32	-	1
65	-	1	60	31	1	85	32	1	33	-	1
66	-	1	61	-	1	86	-	1	50	-	1
67	-	1	65	-	1	88	-	1	51	-	1
69	-	1	66	-	1	89	-	1	56	-	1
70	-	1	67	-	1	90	33	1	57	-	1
71	-	1	68	32	1	95	-	1	99	32	1
75	-	1	69	-	1	96	-	1			
76	-	1	70	31	1	97	32	1			
77	-	1	71	-	1	98	-	1			
89	-	1	74	-	1	99	-	1			
90	38	1	75	-	1						
95	39	1	76	-	1	8 333 31	28	1			
96	-	1	77	-	1	32	-	1			
			85	32	1	33	-	1			
8 325 00	38	1	86	-	1	50	-	1			
01	-	1	88	-	1	51	-	1			
02	-	1	89	-	1	56	-	1			
31	34	1	90	33	1	57	-	1			
32	-	1	95	-	1	99	32	1			
33	-	1	96	-	1						
34	-	1	97	32	1	8 334 00	28	1			
50	-	1	98	-	1	01	-	1			
51	-	1	99	-	1	02	-	1			
56	-	1				03	-	1			
57	-	1				04	-	1			
			8 331 31	28	1	05	-	1			
			32	-	1	07	-	1			
			33	-	1	09	29	1			
			50	-	1	10	-	1			
			51	-	1	12	-	1			
			56	-	1	16	-	1			
			57	-	1	19	33	1			
			99	32	1	21	29	1			
						22	-	1			
			8 332 00	28	1	23	-	1			
			01	-	1	26	33	1			
			02	-	1	29	-	1			
			03	-	1	30	-	1			
			04	-	1	31	-	1			
			05	-	1	32	-	1			
			07	-	1	33	-	1			
			09	29	1	34	-	1			
			10	-	1	35	-	1			
			12	-	1	37	-	1			
			16	-	1	40	30	1			
			19	33	1	41	-	1			
			21	29	1	43	-	1			
			22	-	1	44	32	1			
8 330 00	28	1	23	-	1	45	30	1			
01	-	1	26	33	1	50	-	1			
02	-	1	29	-	1	51	-	1			
03	-	1	29	-	1						

FOLLOW US
ALSO ON

@ legrand.com

 youtube.com/user/legrand

 facebook.com/Legrand

 twitter.com/Legrand

 pinterest.com/legrandgroup

 instagram.com/legrandnews



World Headquarters
and International Department
87045 Limoges Cedex - France
Tel : + 33 (0) 5 55 06 87 87
Fax: + 33 (0) 5 55 06 74 55